

E XCAVATOR PART

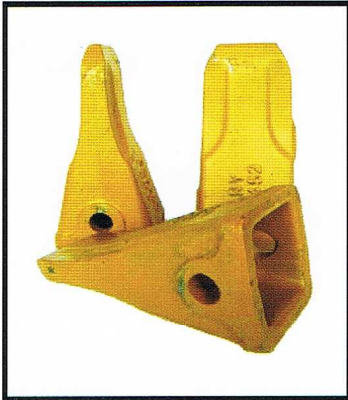

CATERPILLAR Bucket Teeth



Part No: 3G 4452
For earth work
Heavy Duty Long Life



8E 6464 ADAPTER



Part No: 3452
For earth work
Normal Application

CATERPILLAR Bucket Teeth



Part No: 1U 3352
For earth work
Heavy Duty Long Life



8J 4310 ADAPTER



Part No: 3352 cc
For earth work
Normal Application

CATERPILLAR Bucket Teeth

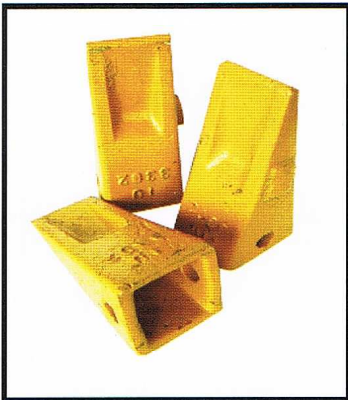

Part No:
1U-3302



3G 6304 ADAPTER

KOBELCO YS35 Bucket Teeth

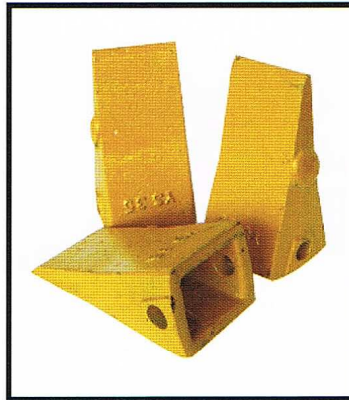

YS35 ADAPTER

KOBELCO 35S Bucket Teeth

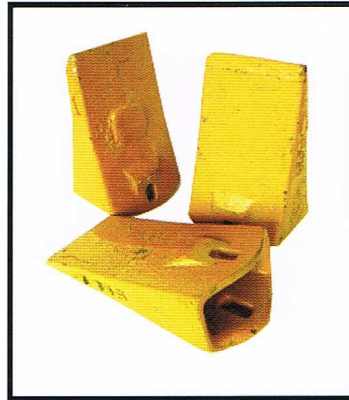

35S ADAPTER

KOBELCO 30S Bucket Teeth

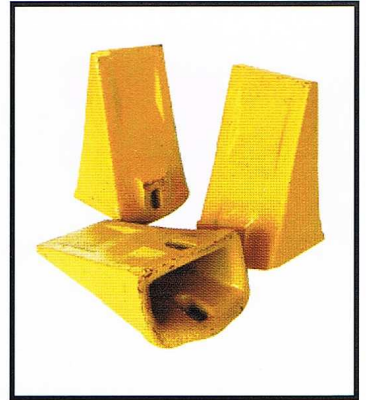

30S ADAPTER

KOMATSU PC300 Bucket Teeth



PC300 ADAPTER

KOMATSU PC200 Bucket Teeth



PC200 ADAPTER

Heavy Duty (Rock)



Heavy Duty (Rock)



4" Weld Tip

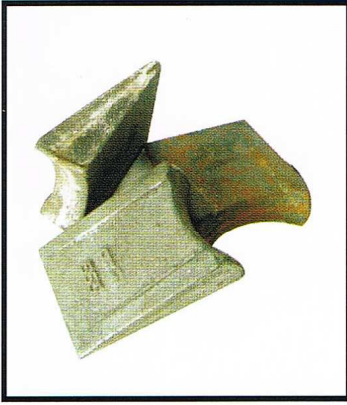

HITACHI Arm Link



Model: EX 200
Part No: 8038558
Specification : Bush Size = \varnothing 80mm

HITACHI Idler Yoke



Model: EX 100 / EX 120
Part No: 1010168
Specification : Dimension : A = 260mm
B = 70mm Hole Size : \varnothing 17mm

HITACHI Idler Yoke

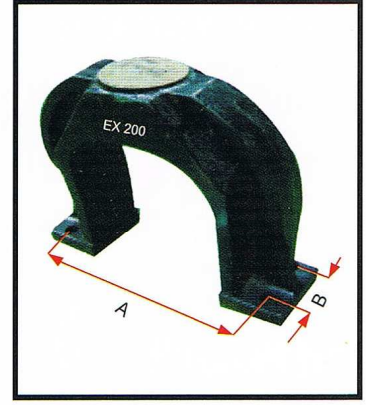

Model: EX 200 / UH 083
Part No: 1005809
Specification : Dimension : A = 285mm
B = 65mm Hole Size : \varnothing 17mm

HITACHI Side Cutter

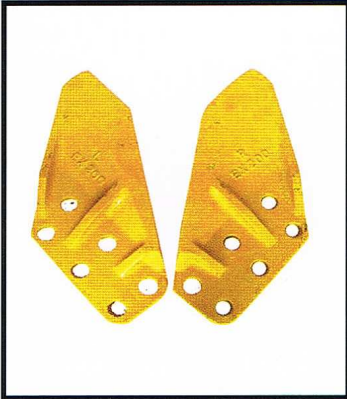

Model: UH 081/ UH 083 /
EX 200 / EX 220
Specification : Both Size: 7/8"x6 holes

HITACHI Side Cutter



Model: EX 100/ EX 120/ UH 063
Specification : Bolt Size = 5/8"x4 holes

HITACHI Side Cutter

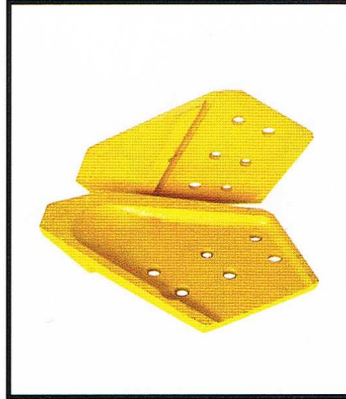

Model: EX 270/ EX 300/ UH 10/
UH 121
Specification : Bolt Size: 7/8"x6 holes

HITACHI Bolt & Nut



Model: EX 100/ EX 120
Part No: 3034939
Specification : Length: 355mm
Material: S45C

HITACHI Bolt & Nut



Model: EX 200
Part No: 3033432
Specification : Length: 460mm
Material: S45C

HITACHI Adjuster



Model: EX 100/ EX 120
Part No: 3034935 (Piston)
3034936 (Flange)
Material: S45C

HITACHI Adjuster



Model: EX 200
Part No: 3033431 (Piston)
3033434 (Flange)
Material: S45C

HITACHI Arm Booster



Model: EX 100/ EX 120/ UH 063
Specification:
Dimension: \varnothing 139mm X h 253mm
65mm x 80mm x Bush size: 70mm

HITACHI Arm Booster

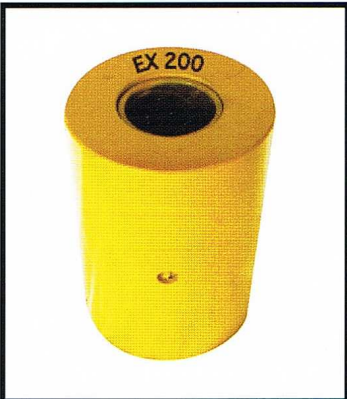

Model: EX 200/ UH 083/ UH 081
Specification:
Dimension: \varnothing 188mm X h 305mm
80mm x 95mm x Bush size: 70mm

HITACHI Arm Booster

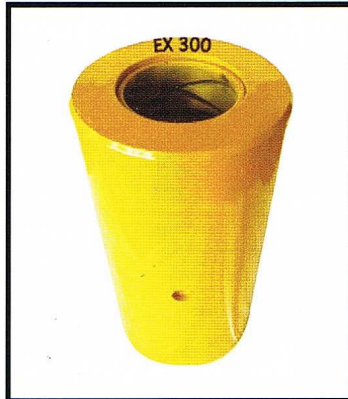

Model: EX 300
Specification:
Dimension: \varnothing 197mm X h 408mm
100mm x 115mm x Bush size: 63mm

HITACHI Sprocket

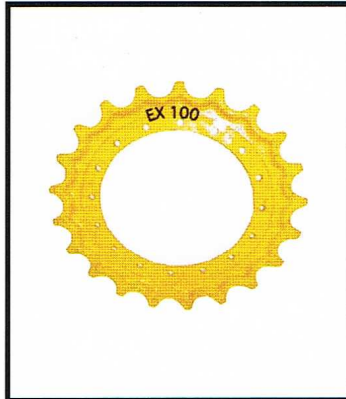

Model: EX 100/ EX 120
Part No: 1010325
Specification :
Hardness: 40~45 HRC
Teeth: 21 Holes: 16 x \varnothing 18mm

HITACHI Sprocket

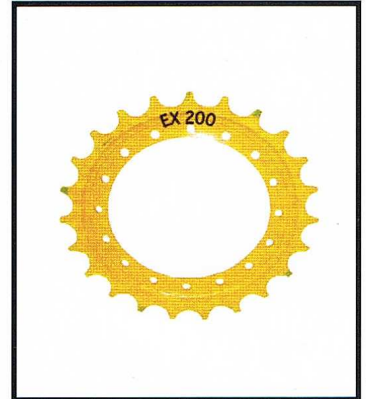

Model: EX 200
Part No: 1010204
Specification :
Hardness: 40~45 HRC
Teeth: 23 Holes: 16 x \varnothing 22mm

KOMATSU Arm Booster

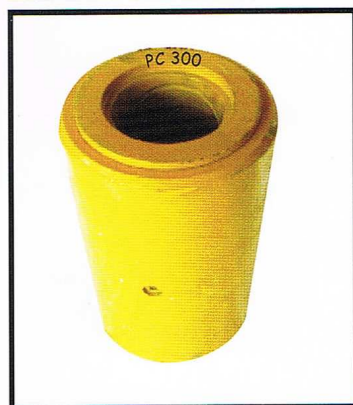

Model: PC 300-5/6
 Specification:
 Dimension: Ø180mm X h 345mm
 90mm x 110mm with Bush size: Flange

KOBELCO Arm Booster



Model: SK 200/07
 Specification:
 Dimension: Ø170mm X h 330mm
 80mm x 95mm with Bush size: Flange

SUMITOMO Arm Booster



Model: SH 2800
 Specification:
 Dimension: Ø168mm X h 308mm
 70mm x 90mm x Bush size: 80mm

MITSUBISHI Arm Booster



Model: MS 180
 Specification:
 Dimension: Ø168mm X h 303mm
 75mm x 90mm x Bush size: 80mm

KOMATSU Bucket Pin



Model: PC 200/ PC 300 - 5/6
 Specification : Material : S45C
 Hardness: 45~50 HRC

HITACHI Bucket Pin



Model: EX 100/ EX 120/ UH 063/
 EX 200/ UH 081/ EX 300
 Specification : Material : S45C
 Hardness: 45~50 HRC

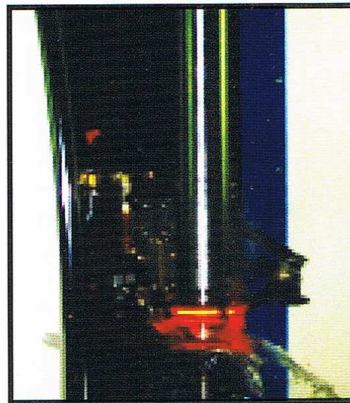

Induction Hardening Process

KOMATSU Side Cutter

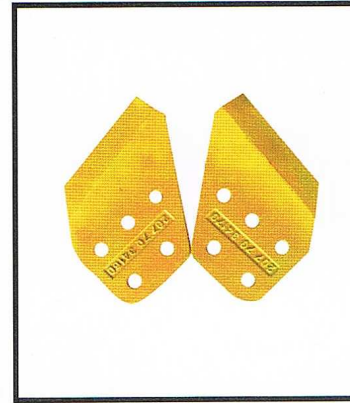

Model: PC 300/ PC 303/ PC 315/PC330
 Specification : Bolt Size: 1" x 5 holes

KOMATSU Side Cutter



Model: PC 200/ PC 220
 Specification :
 Bush Size = 7/8" X 4 holes

KOBELCO Side Cutter



Model: SK 300/ K 912
 Specification :
 Bolt Size: 1" x 5 holes

KOBELCO Sprocket



Model: SK 200/ SK 200LC
 Part No: 2404N262
 Specification :
 Hardness: 40~45 HRC
 Teeth: 21 Holes: 22 x Ø 19mm

KOMATSU Sprocket



Model: PC 200-3/5
 Part No: 205-27-71281
 Specification :
 Hardness: 40~45 HRC Teeth: 21
 Holes: 20 x Ø 17mm (PC 200-3)
 Holes: 20 x Ø 19mm (PC 200-5)

KOMATSU Sprocket

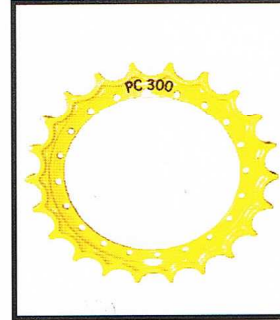

Model: PC 300-3/5
 Part No: 205-27-33222
 Specification :
 Hardness: 40~45 HRC
 Teeth: 22
 Holes: 20 x 21mm

CASE PART



CASE 2300 Bucket Teeth

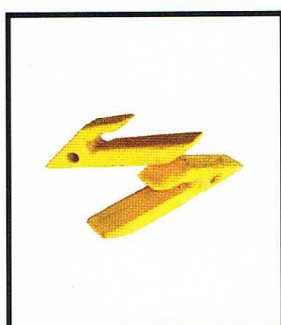

2300 ADAPTER

JCB Bucket Teeth

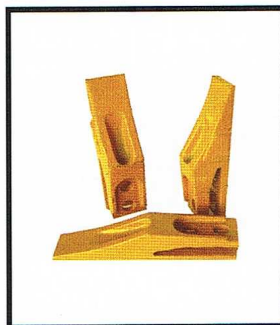

CASE Coupler



Model: 580K/ 580L
 Part No : D 139084

CASE Arm Link



Model: 580K/ 580L
 Part No : D 140007

CATERPILLAR PART



CATERPILLAR Pin



Model: 950 / 966C
Specification : Material: S45C
Hardness: 45 ~ 50 HRC

CATERPILLAR Piston

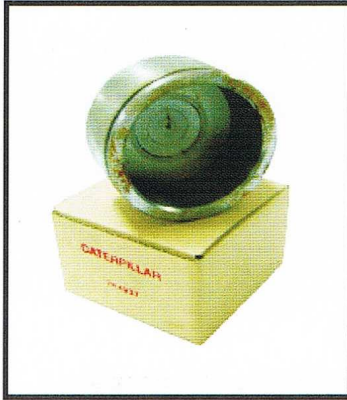

Model: 950
Specification : Material: S45C
Hardness: 25 ~ 35 HRC

CATERPILLAR Bearing

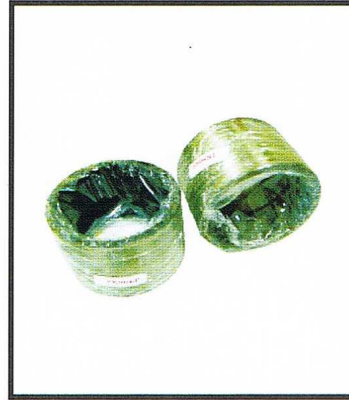

Model: 950 / 966C
Specification : Material: S45C
Hardness: 45 ~ 50 HRC

CATERPILLAR Clamp



Model: D6C / D6D
Part No: 4S 9062

CATERPILLAR Cap & Bearing

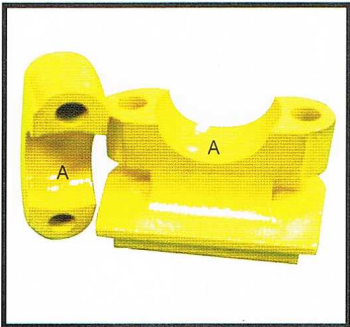

Model: D6C
Part No: 6F 2905 (Cap)
6F 2904 (Bearing)
A: Area Hardness: 40 HRC

CATERPILLAR Trunnion



Model: D6C
Part No: 6J 5462
A: Area Hardness: 40 HRC

CATERPILLAR Bearing



Model: D6C / D6D / D7
Part No: 3J 6575
A: Area Hardness: 40 HRC

CATERPILLAR Sprocket



Model: D4
Part No: 7K 2514
Specification :
Hardness: 40~45 HRC Teeth: 29

CATERPILLAR End Bit



Model: D6C
Part No: 3G 8297/ 3G 8298
Specification: Thickness= 1 3/8"

CATERPILLAR End Bit



Model: D6C / D6D
Part No: 6J 0275 R / 6J 0276L
Specification: Thickness= 3/4"

CATERPILLAR D5 Segment Group



Part No: 5S 0836
Specification :
Tip Hardness: 40~50 HRC
Bolt Size= 5/8" Quantity: 9 pcs / Set

CATERPILLAR Bucket Teeth Lock Pin



Model: 1U 3452
Part No: 8E 0468 (Lock Pin)
8E 8469 (Retainer)
Size: Length=133.7mm Ø 23.7mm } Pin
Ø 39mm (Outside)
Ø 23.7mm (Inside) }
Thickness=9.2mm

CATERPILLAR D6C Segment Group

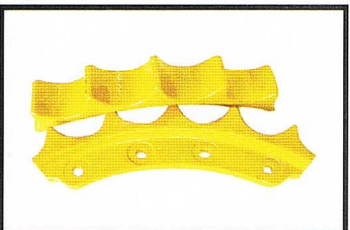

Part No: 8P 5837
Specification :
Tip Hardness: 40 ~ 50 HRC
Bolt size=5/8" Quantity=5 pcs/ set

CATERPILLAR D6C Segment Group

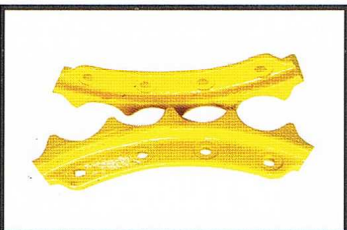

Part No: 1171616
Specification :
Tip Hardness: 40 ~ 50 HRC
Bolt size=3/4" Quantity=5 pcs/ set

CATERPILLAR 966 Bucket Teeth

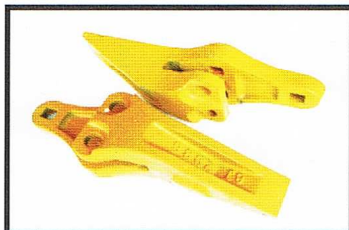

Part No: 8J 2936

CATERPILLAR 950 Bucket Teeth



Part No: 8J 4692

**CATERPILLAR/ KOMATSU/
MOTOR GRADER**

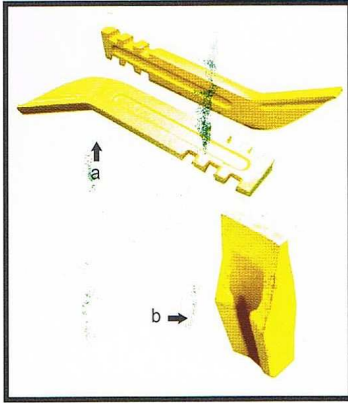

a: Shank Part No: 9F 5124
b: Tip Part No: 2D 5572

CATERPILLAR Guard Plate



Model: D6C / D6D
Part No: 7M 1776
Specification : Hole size: \varnothing 1/2"
Hole size: \varnothing 5/8"

CATERPILLAR Strip Guide

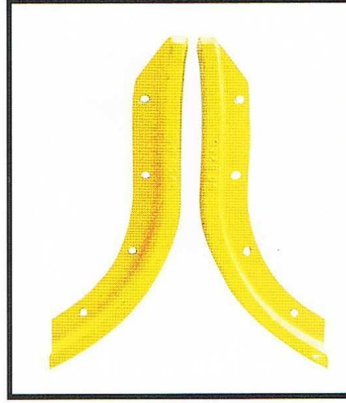

Model: D6C / D6D
Part No: 9S 8245 - 9S 8246
Specification : Bolt size: 1/2"

**CATERPILLAR Top Roller
Bracket**



Model: D6C / D6D
Part No: 1S 8734

KOMATSU PARTS

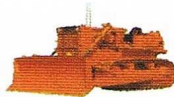

KOMATSU U-Frame Bracket



Model: (A6) D60 / LE 70
Part No: 1447013210 R
1447013220 L

KOMATSU Joint

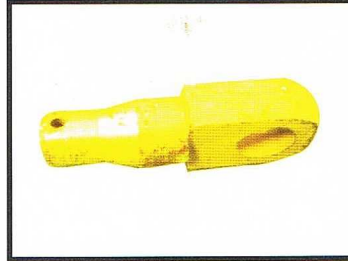

Model: (A6) D60 / LE 70
Part No: 1447012181

KOMATSU Bracket

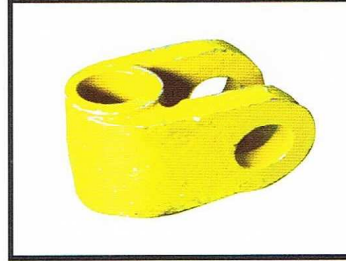

Model: A6 / LE 70
Part No: 1448546140

KOMATSU Bucket Teeth Lock Pin

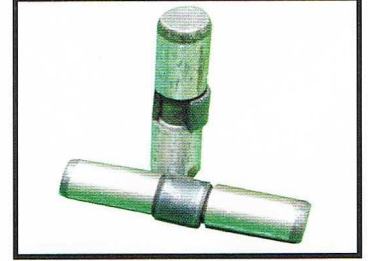

Model: PC 300-5/6
Material: S45C
Size: Length=120mm \varnothing 24.5mm

KOMATSU Center Pin



Model: D60 / LE70
Part No: 1448542870
Specification : Hole size: \varnothing 60mm

KOMATSU Center Pin



Model: D60 / LE70
Part No: 1447013120
Specification : Hole size: \varnothing 55mm

KOMATSU End Bit

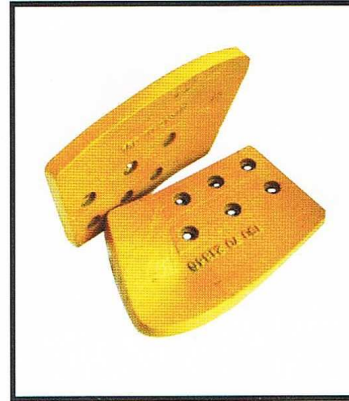

Model: LE70
Part No: 1507021346 / 1507021356
Specification : Thickness=1 3/8"

KOMATSU End Bit

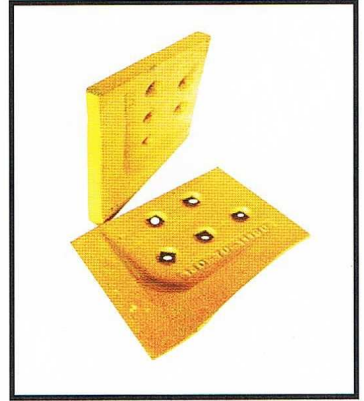

Model: A6
Part No: 1407011170 / 1407011180
Specification : Thickness=1"

**KOMATSU Bulldozer
Segment Group**



Part No: 1412732410
Specification :
Tip Hardness: 40~50 HRC
Bolt Size: 5/8"
Quantity: 9pcs/set

MJP MJ Processing Sdn. Bhd. 828607-U

No.19A, Jalan TS6/10A, Taman Industri Subang,
47510 Subang Jaya, Selangor, Malaysia

Tel:+60-3-5635-1768 Fax:+60-3-5635-1769

<http://www.mjprocessing.com/>